

Dati tecnici

Technical data

Olio idraulico Mineral oil	ISO 6743/4 DIN 51524
Viscosità fluido Fluid viscosity	10-500 mm ² /s 45 to 2000 ssu (6 to 420 cSt)
Classe di contaminazione max con filtro Max contamination index with filter	ISO 4406:1999 Classe 19/17/14
Temperatura del fluido Fluid temperature	-20°C +80°C -4°F + 176°F
Temperatura ambiente Ambient temperature	-20°C +50°C -4°F + 122°F

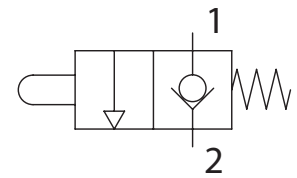

Normalmente chiusa
Normally closed

È indispensabile l'utilizzo di un filtro (filtrazione consigliata 15 micron) per proteggere la valvola

It is necessary a filter use to protect the valve (advised filtration 15 micron)

Perdite di carico *Pressure drops*

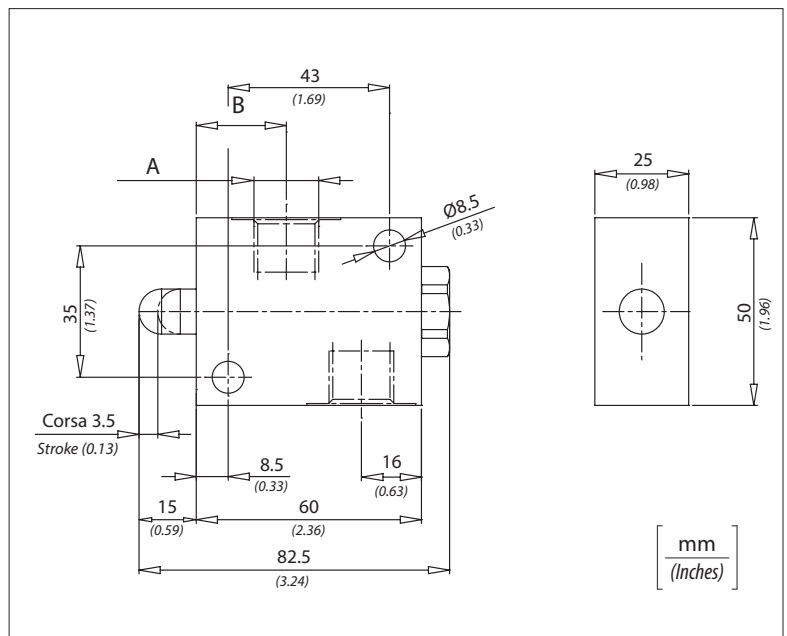
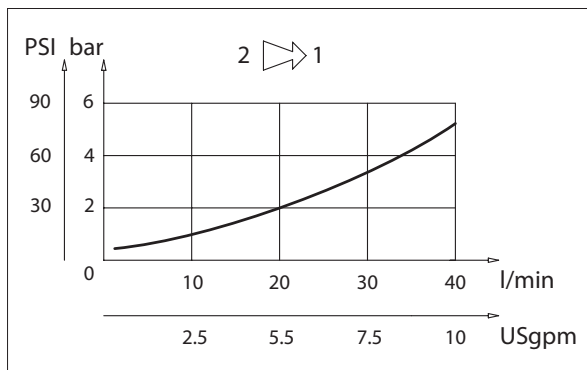

Caratteristiche tecniche / *Technical performances*

Codice Code	A	B	Portata max Max Flow l/min - USgpm	Pressione Max Max pressure bar / PSI	Peso approssimativo / Kg Approx weight / lb
FCM140N	BSPP 1/4	26,5 (1.04)	40 (10.5)	350 (5000)	0,50 (1.10)
FCM380N	BSPP 3/8	24 (0.95)			

Codice ordinazione / *Ordering code*

FCM - X

X	Dimensione / Size
140N	BSPP 1/4
380N	BSPP 3/8



FCM120

Valvole di fine corsa
End-stroke valves

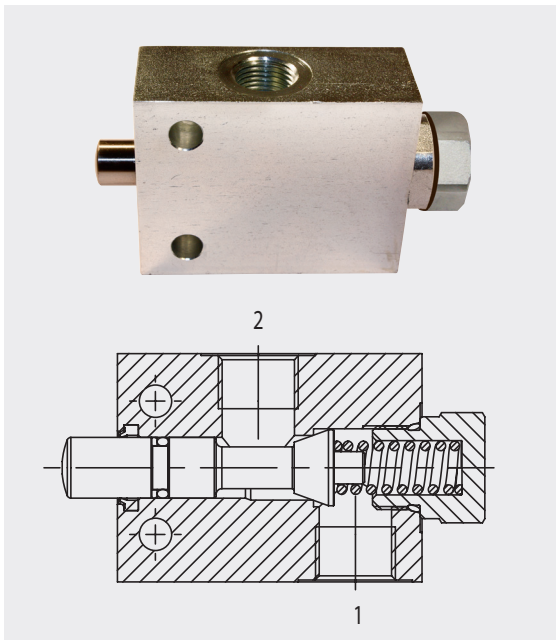

Dati tecnici Technical data	
Olio idraulico Mineral oil	ISO 6743/4 DIN 51524
Viscosità fluido Fluid viscosity	10-500 mm ² /s 45 to 2000 ssu (6 to 420 cSt)
Classe di contaminazione max con filtro Max contamination index with filter	ISO 4406:1999 Classe 19/17/14
Temperatura del fluido Fluid temperature	-20°C +80°C -4°F + 176°F
Temperatura ambiente Ambient temperature	-20°C +50°C -4°F + 122°F

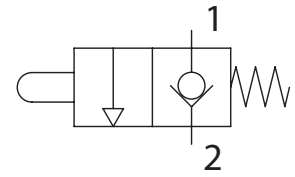

Normalmente chiusa
Normally closed

È indispensabile l'utilizzo di un filtro (filtrazione consigliata 15 micron) per proteggere la valvola
It is necessary a filter use to protect the valve (advised filtration 15 micron)

Perdite di carico *Pressure drops*

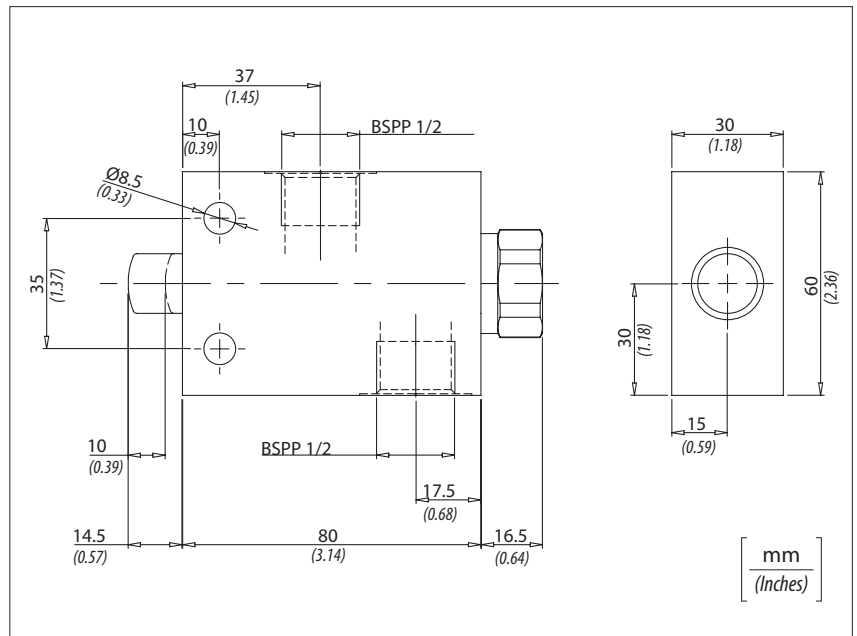
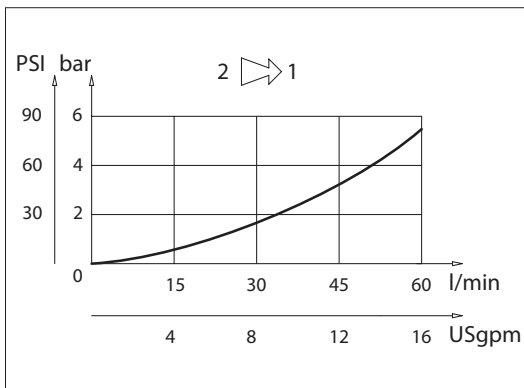

Caratteristiche tecniche Technical performances

Codice Code	Portata max Max Flow l/min - USgpm	Pressione Max Max pressure bar / PSI	Peso approssimativo / Kg Approx weight / lb
FCM120N	60 (16)	300 (4350)	1,50 (3.3)

Codice ordinazione Ordering code

FCM120N