

AP 1200 EB



PURCHASE CODES

AP 1200 EB three-phase **3RAP1200EB**

SPARE PARTS

Frame	3CNEO08586.1
Shock isolating mounting (4 pcs)	3KIT4232
Cooling element	1RO08423
Electric fan	1VNEO08586

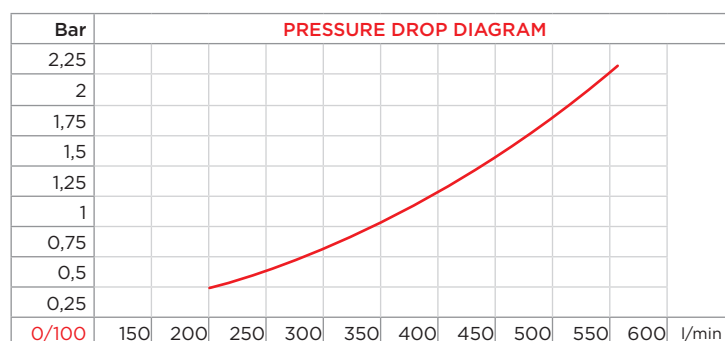
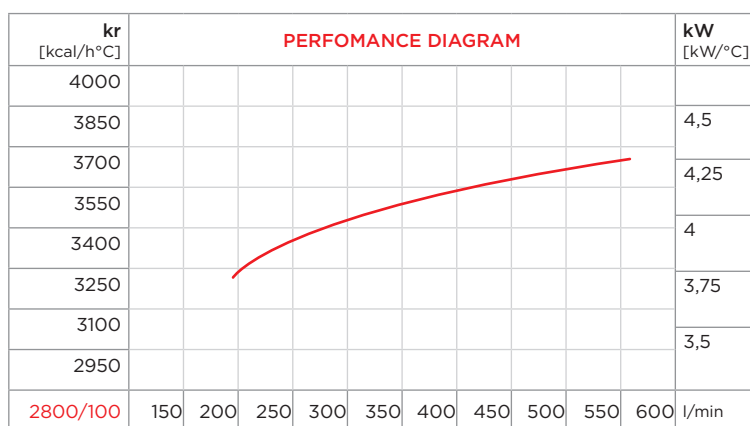

CORRECTION FACTOR

cSt	22	30	46	68	100	150	220
f	0,6	1	1,5	2,3	3,5	5	7

- Dimensions and technical characteristics are not binding

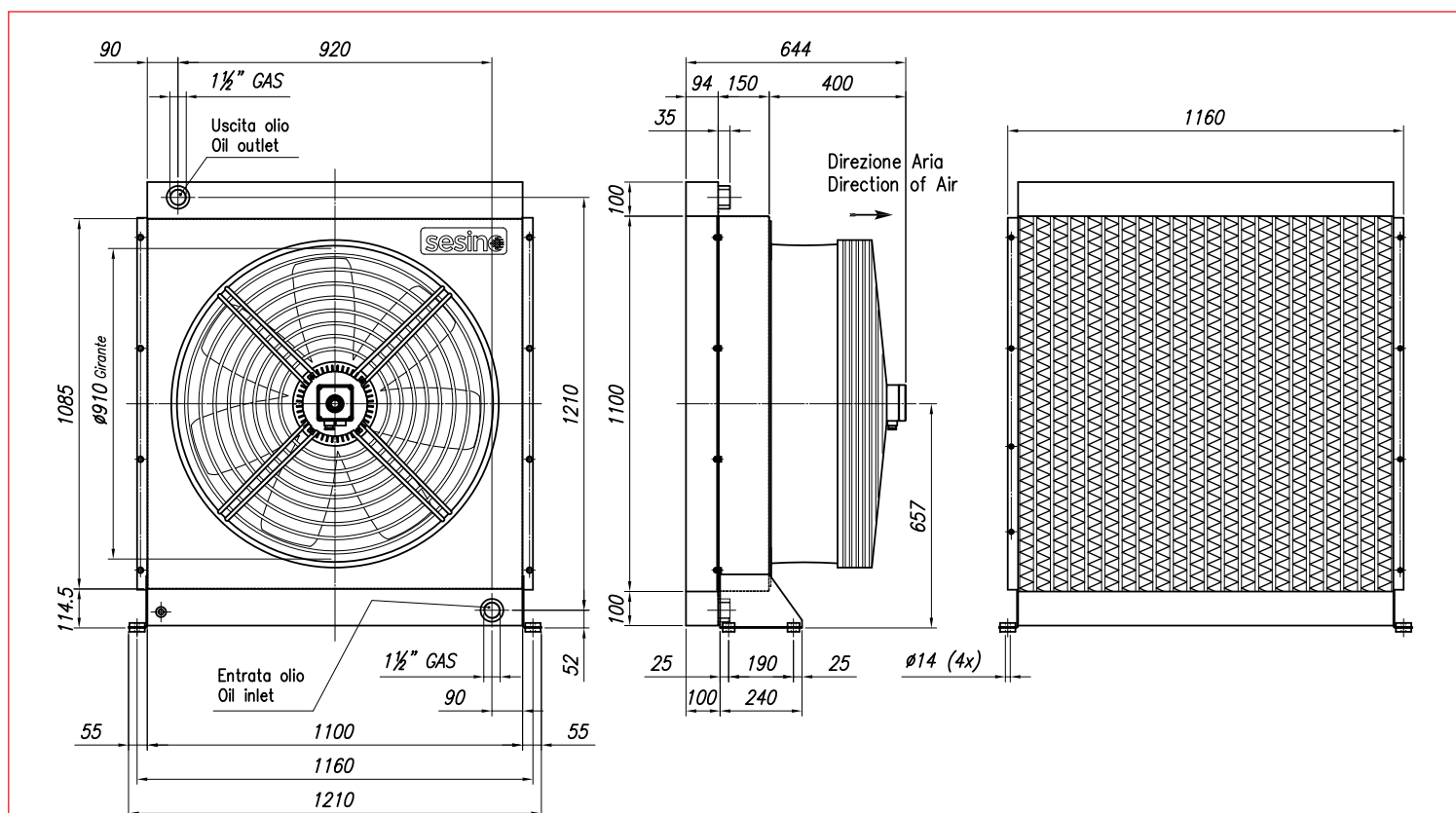

OIL FLOW	CAPACITY	VOLTAGE	FREQUENCY	POWER	CURRENT	AIR FLOW	PROTECTION	NOISE LEVEL	WEIGHT	ø FAN
l/min	l	V	hz	W	A	m³/h	IP	dB(A)	kg	mm
200-550	35	400	50	1650	4,1	14.000	54	70	135	910