

AP 2/730 EM



PURCHASE CODES

AP 2/730 EM three-phase 400V 50HZ with thermo-switch	3RAP2730EM50T47 3RAP2730EM50T60
AP 2/730 EM three-phase 480V 60HZ with thermo-switch	3RAP2730EM60T47 3RAP2730EM60T60
AP 2/730 EM three-phase 400V 50HZ without thermo-switch	3RAP2/730EM50ST
AP 2/730 EM three-phase 480V 60HZ without thermo-switch	3RAP2/730EM60ST

SPARE PARTS

Cooling element	3RNL2/730A
Frame	3CNAP2/730EM.1
Electric fan 400V 50Hz	1VNAP680EM50
Electric fan 480V 60Hz	1VNAP680EM60
Thermo-switch 47-36	1TRM 47-36
Thermo-switch 60-49	1TRM 60-49

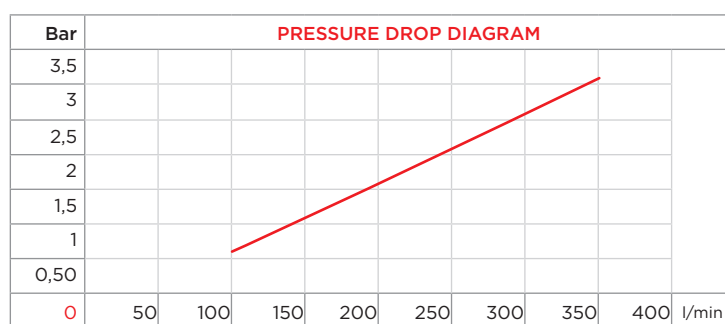
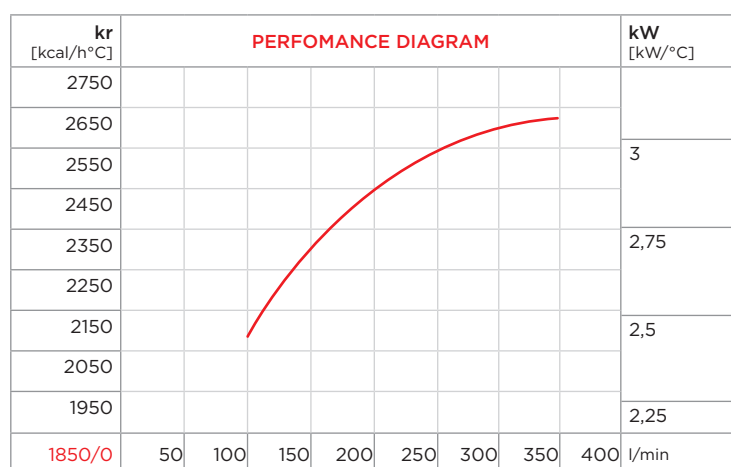

CORRECTION FACTOR

cSt	22	30	46	68	100	150	220
f	0,6	1	1,5	2,3	3,5	5	7

- Dimensions and technical characteristics are not binding

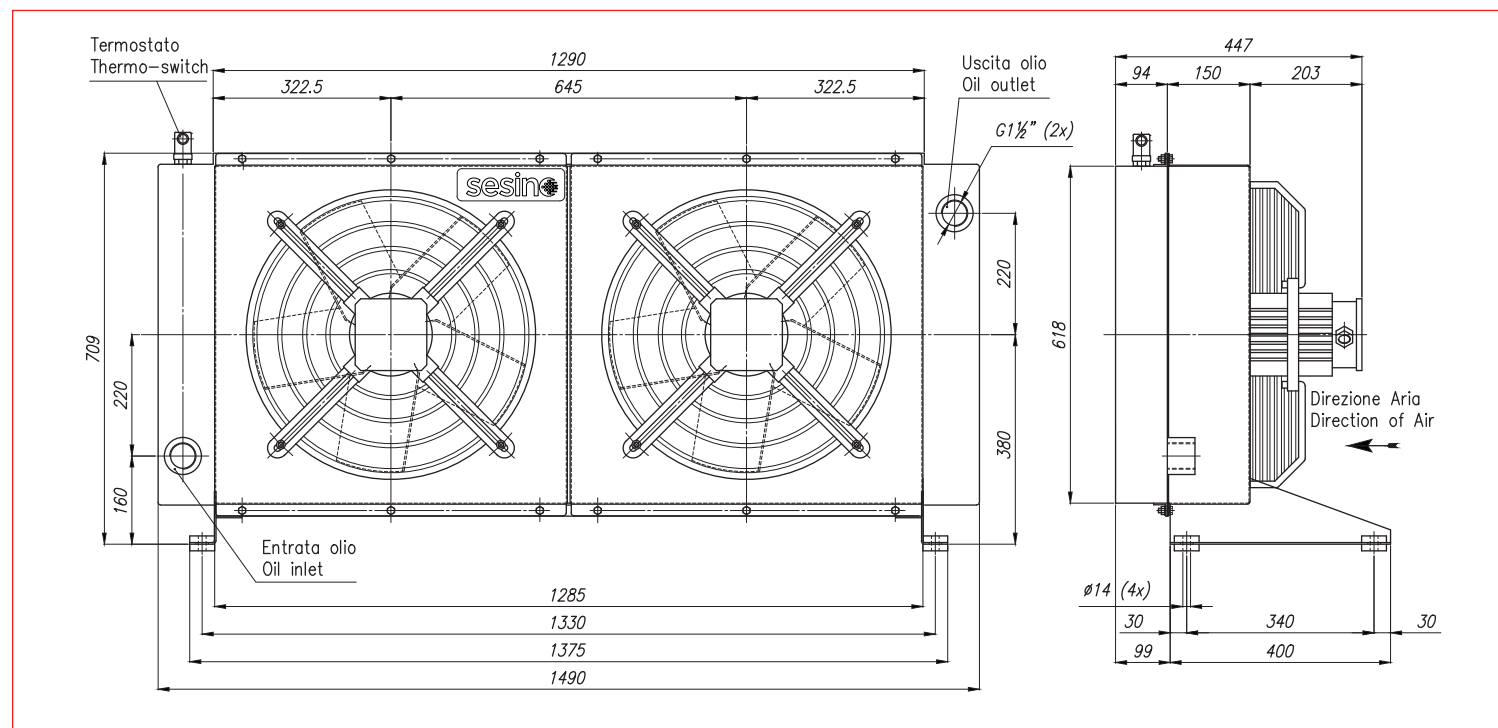

CODE	OIL FLOW l/min	CAPACITY l	VOLT. V	FREQ. Hz	POWER W	CURRENT A	AIR FLOW m³/h	PROTECTION IP	NOISE LEV. dB(A)	WEIGHT kg	ø FAN mm	TEMP. °C
3RAP2/730EM50ST	100-350	30	400	50	2x 725	2x 1,34	2x 7800	56	77	145	500	-20/+40
3RAP2/730EM60ST	100-350	30	480	60	2x 816	2x 1,27	2x 8200	56	77	145	500	-20/+40