



PW..A type flow control pressure compensated valves - 2 way

- With reverse free flow check
- From SAE08 to SAE16 cavities

Technical specifications and diagrams are measured with mineral oil of 46 cSt viscosity at 40°C (104°F) temperature.

	PW08A	PW10A	PW12A	PW16A
Nominal flow	10 l/min (2.6 US gpm)	30 l/min (7.9 US gpm)	50 l/min (13 US gpm)	90 l/min (24 US gpm)
Max. pressure	350 bar (5100 psi)			
Fluid	mineral based oil			
Viscosity	10-200 cSt			
Max level of contamination	20/18/14 ISO4406			
Fluid temperature	with NBR seals with FPM seals	from -20°C (-4°F) to 80°C (176°F) from -20°C (-4°F) to 100°C (212°F)		
Environmental temp. for working conditions	from -20°C (-4°F) to 50°C (122°F)			
Cavity	SAE 08/2 A	SAE 10/2 A	SAE 12/2 A	SAE 16/2 A
Weight	0.22 kg (0.48 lb)	0.30 kg (2.20 lb)	0.72 kg (1.58 lb)	0.98 kg (2.16 lb)

NOTE - For different conditions, please contact Walvoil Sales Dpt.

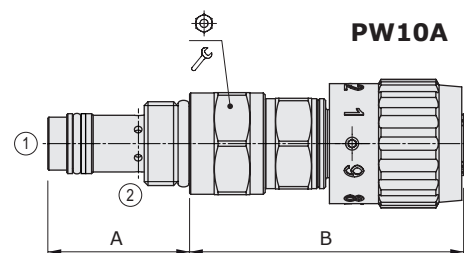
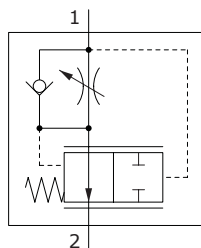

Valve type	A		B		⊕	🔧	Nm	lbft
	mm	in	mm	in				
PW08A/AM	36.6	1.44	64.5	2.54	24	30	22	
PW10A/AM	37.5	1.48	71.9	2.83	27	50	36	
PW12A/AM	58.5	2.30	64.5	2.54	32	80	59	
PW16A/AM	68	2.68	86	3.39	41	100	74	

For dimensions with different type of adjustment see page 212

Ordering codes and description composition

PW08A/AM1B

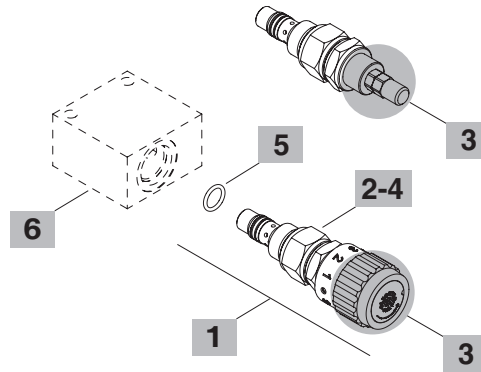
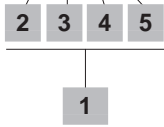

1 Cartridges

TYPE	CODE	DESCRIPTION
SAE cavity 08/2 A		
PW08A/AM1B	0PW08002000	Handknob adjustment
PW08A/AS1B	0PW08002003	Screw type adjustment
SAE cavity 10/2 A		
PW10A/AM1B	0PW10002000	Handknob adjustment
PW10A/AS1B	0PW10002001	Screw type adjustment
SAE cavity 12/2 A		
PW12A/AM1B	0PW12002000	Handknob adjustment
PW12A/AS1B	0PW12002001	Screw type adjustment
SAE cavity 16/2 A		
PW16A/AM1B	0PW16002000	Handknob adjustment
PW16A/AS1B	0PW16002001	Screw type adjustment

2 Pressure drop from 1 to 2

TYPE	DESCRIPTION
A	12 bar (170 psi)

3 Adjustments

TYPE	DESCRIPTION
S	Screw
M	Handknob

4 Pressure drop from 2 to 1

TYPE	DESCRIPTION
1	0.5 bar (7.3 psi)

5 Seals

TYPE	DESCRIPTION
B	NBR (Buna) Std configuration without addition
V	For valve with FPM (Viton) o-ring seals, contact Sales Dept.

6 Valve body

TYPE	CODE	DESCRIPTION
SAE 08/2-G 3/8	3CC0820C11	Aluminium body for cavity 08 valve, G3/8 std thread
SAE 10/2-G 3/8	3CC1020C11	Aluminium body for cavity 10 valve, G3/8 std thread
SAE 12/2-G 1/2	3CC1220D11	Aluminium body for cavity 12 valve, G1/2 std thread
SAE 16/2-G 3/4	3CC1620E11	Aluminium body for cavity 16 valve, G3/4 std thread

Note: aluminium body can stand up to 210 bar (3050 psi)
For steel bodies or different threading see from page 215

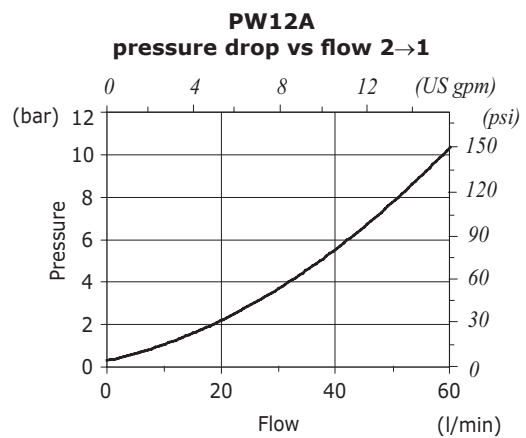
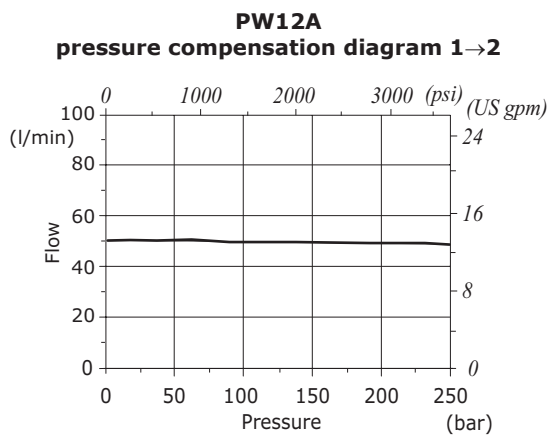
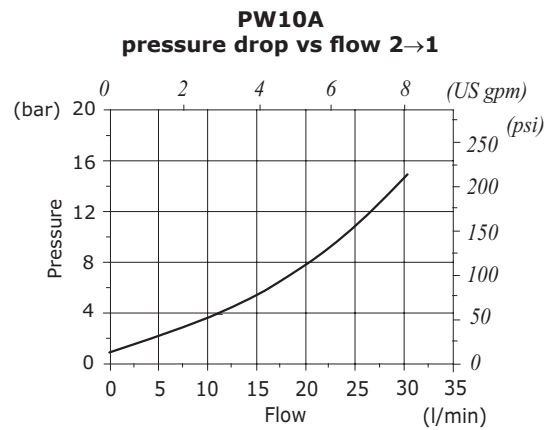
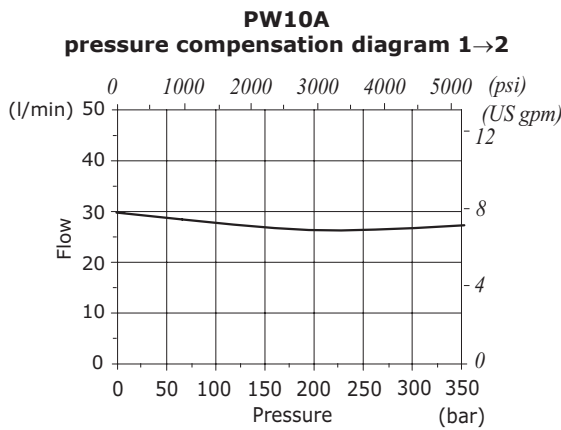
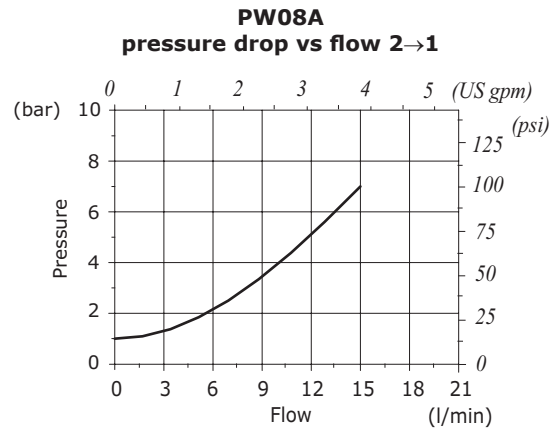
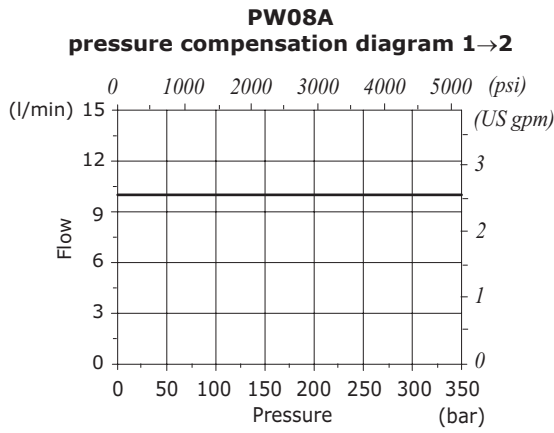

Rating diagrams

