



MD..M type shockless pressure relief valve - 2 way

- Direct acting
- Poppet type
- From SAE10 to SAE12 cavities

Technical specifications and diagrams are measured with mineral oil of 46 cSt viscosity at 40°C (104°F) temperature.

		MD10M	MD12M
Nominal flow		60 l/min (15.8 US gpm)	100 l/min (26.4 US gpm)
Max. pressure		350 bar (5100 psi)	
Oil leakage	at 80% of max. pressure setting	5 cm ³ /min (0.3 in ³ /min)	5 cm ³ /min (0.3 in ³ /min)
Fluid		mineral based oil	
Viscosity		10-200 cSt	
Max level of contamination		20/18/14 ISO4406	
Fluid temperature	with NBR seals	from -20°C (-4°F) to 80°C (176°F)	
Environmental temp. for working conditions		from -20°C (-4°F) to 50°C (122°F)	
Cavity		SAE 10/2	SAE 12/2
Weight		0.200 kg (0.44 lb)	0.355 kg (0.78 lb)

NOTE - For different conditions, please contact Walvoil Sales Dpt.

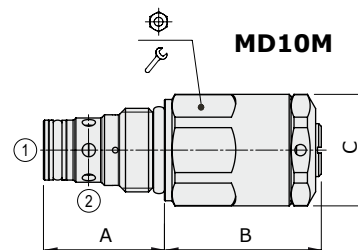
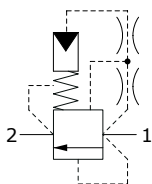

Valve type	A		B		C				Nm	lbft
	mm	in	mm	in	mm	in				
MD10M	32	1.25	73.5	2.89	ø29.5	ø1.16	27	50	37	
MD12M	46	1.81	92.5	3.64	ø35	ø1.38	32	80	59	

Ordering codes and description composition

MD10M/313B

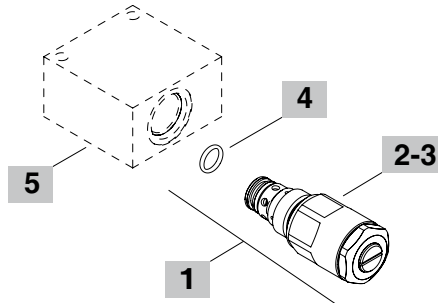
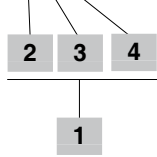

1 Cartridges

TYPE	CODE	DESCRIPTION
SAE cavity 10/2		
MD10M/313B	OMD10002027	Pressure range 13
SAE cavity 12/2		
MD12M/513B	OMD12002004	Pressure range 13

2 Reaction time

TYPE	DESCRIPTION
2	Reaction time 0.2 sec. (± 0.1 sec.)
3	Reaction time 0.3 sec. (± 0.1 sec.)
4	Reaction time 0.4 sec. (± 0.1 sec.)
5	Reaction time 0.5 sec. (± 0.1 sec.)
6	Reaction time 0.6 sec. (± 0.1 sec.)
7	Reaction time 0.7 sec. (± 0.1 sec.)

3 Pressure range

TYPE	DESCRIPTION
SAE cavity 10/2	
11	Pressure range 130÷200 bar (1900÷2900 psi). Pressure ratio 1.9
12	Pressure range 180÷240 bar (2610÷3480 psi). Pressure ratio 2.2
13	Pressure range 220÷290 bar (3190÷4200 psi), Setting 250 bar (3625 psi) at 25 l/min (6.6 US gpm). Pressure ratio 2.4
21	Pressure range 170÷270 bar (2465÷3915 psi). Pressure ratio 2.5
22	Pressure range 220÷290 bar (3190÷4200 psi). Pressure ratio 2.8
SAE cavity 12/2	
11	Pressure range 125÷155 bar (1810÷2250 psi). Pressure ratio 1.7
12	Pressure range 160÷190 bar (2320÷2760 psi). Pressure ratio 1.9
13	Pressure range 180÷240 bar (2610÷3480 psi), Setting 220 bar (3190 psi) at 60 l/min (16 US gpm). Pressure ratio 2.2
21	Pressure range 150÷185 bar (1900÷2685 psi). Pressure ratio 2
22	Pressure range 190÷235 bar (2760÷3400 psi). Pressure ratio 2.35
23	Pressure range 230÷275 bar (3335÷3990 psi). Pressure ratio 2.55

Note: supplied valves are set at the requested pressure and sealed

4 Seals

TYPE	DESCRIPTION
B	NBR (Buna) o-ring seals, std configuration

5 Valve body

TYPE	CODE	DESCRIPTION
SAE 10/2-G 3/8	3CC1020C11	Aluminium body for cavity 10 valve, G 3/8 std thread
SAE 12/2-G 1/2	3CC1220D11	Aluminium body for cavity 12 valve, G 1/2 std thread

Note: aluminium body can stand up to 210 bar (3050 psi)
For steel bodies or different threading see from page 215

MD10M performance curve example with typical dimensions

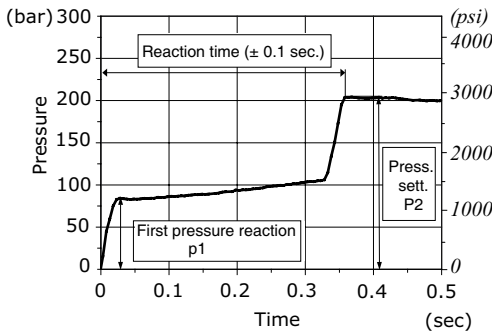

Pressure ratio: $R_p = \frac{p_2}{p_1}$

First pressure reaction: $p_1 = \frac{p_2}{R_p}$

MD10M pressure vs. flow at max. and min. setting

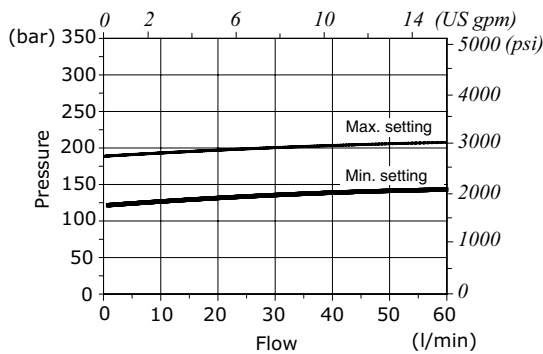

Pressure range 11
130 ÷ 200 bar
(1900 ÷ 2900 psi)
Pressure ratio 1.9
Q=60l/min
(15.8 US gpm)

MD10M performance curve at max. and min. setting

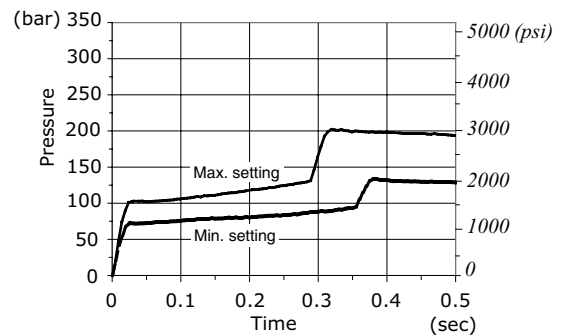

MD10M pressure vs. flow at max. and min. setting

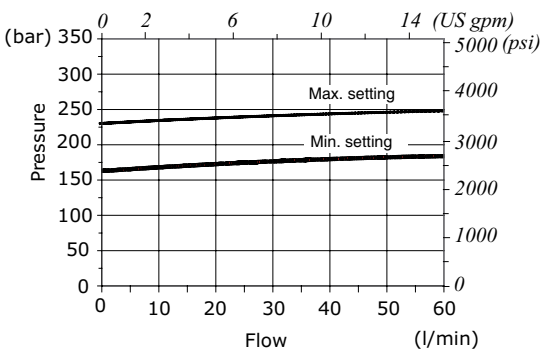

Pressure range 12
180 ÷ 240 bar
(2610 ÷ 3480 psi)
Pressure ratio 2.2
Q=60l/min
(15.8 US gpm)

MD10M performance curve at max. and min. setting

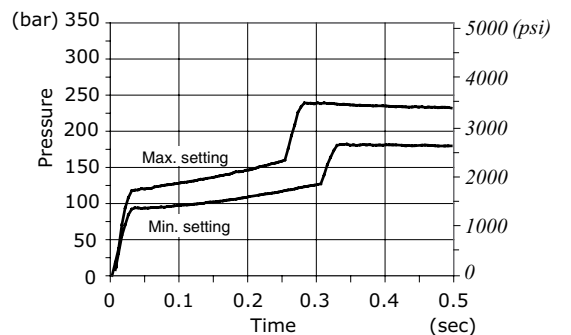

MD10M pressure vs. flow at max. and min. setting

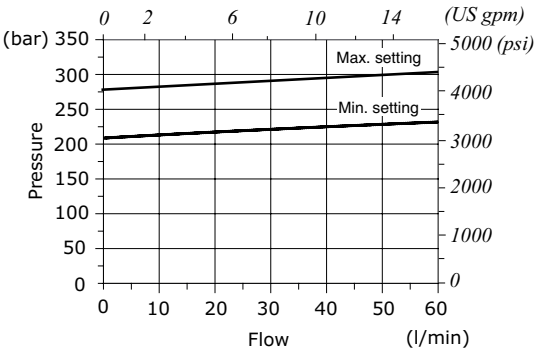

Pressure range 13
220 ÷ 290 bar
(3190 ÷ 4200 psi)
Setting 250 bar (3625 psi) at 25 l/min
(6.6 US gpm)
Pressure ratio 2.4
Q=60l/min
(15.8 US gpm)

MD10M performance curve at max. and min. setting

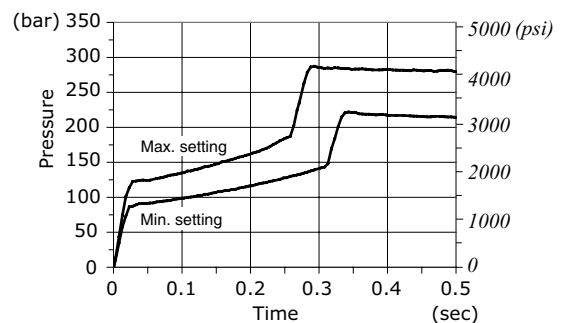

Rating diagrams

MD10M pressure vs. flow
at max. and min. setting

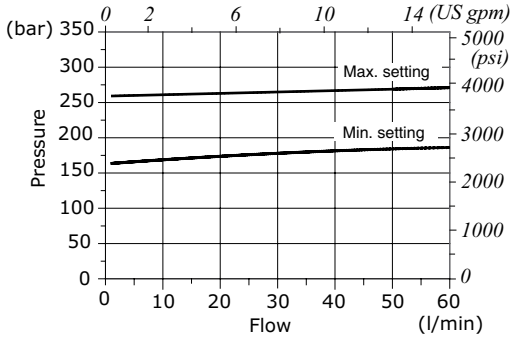

Pressure range 21
170÷270 bar
(2465÷3915 psi)
Pressure ratio 2.5
Q=60l/min
(15.8 US gpm)

MD10M performance curve
at max. and min. setting

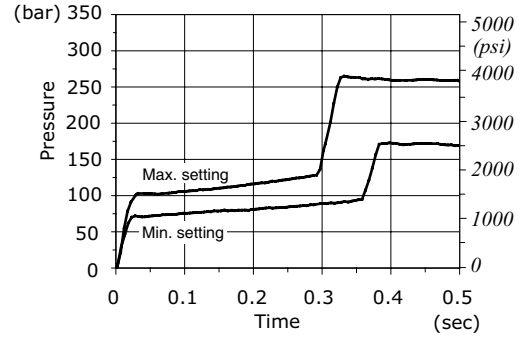

MD10M pressure vs. flow
at max. and min. setting

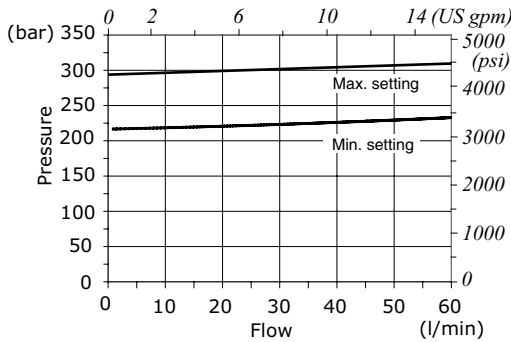

Pressure range 22
220÷290 bar
(3190÷4200 psi)
Pressure ratio 2.8
Q=60l/min
(15.8 US gpm)

MD10M performance curve
at max. and min. setting

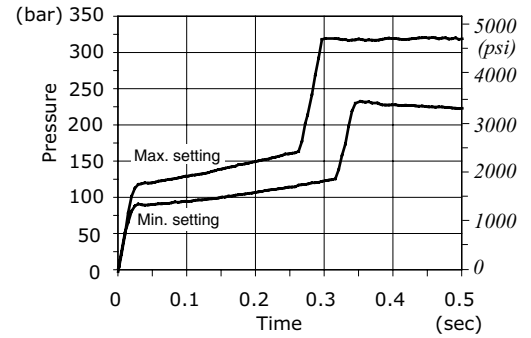

MD12M performance curve example with typical dimensions

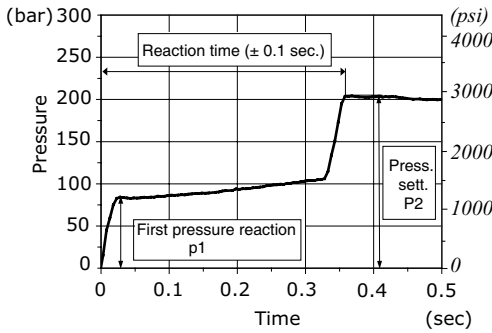

Pressure ratio: $R_p = \frac{p_2}{p_1}$

First pressure reaction: $p_1 = \frac{p_2}{R_p}$

MD12M pressure vs. flow at max. and min. setting

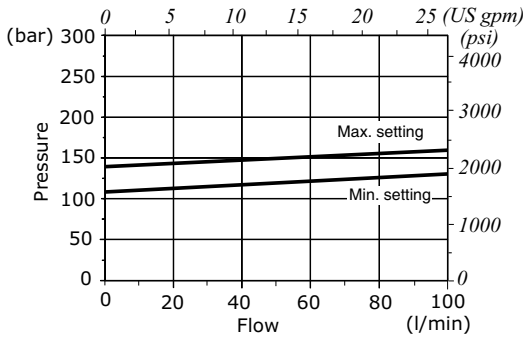

Pressure range 11
125 ÷ 155 bar
(1810 ÷ 2250 psi)
Pressure ratio 1.7
Q=100 l/min
(26.4 US gpm)

MD12M performance curve at max. and min. setting

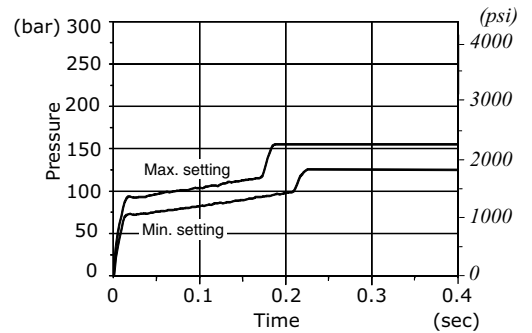

MD12M pressure vs. flow at max. and min. setting

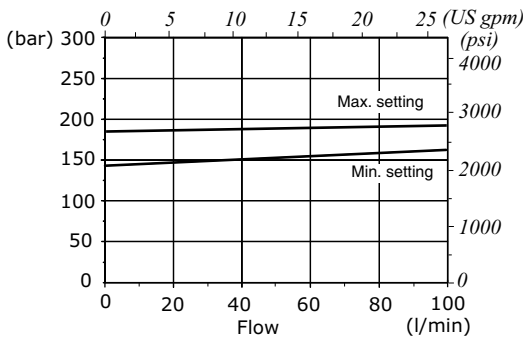

Pressure range 12
160 ÷ 190 bar
(2320 ÷ 2760 psi)
Pressure ratio 1.9
Q=100 l/min
(26.4 US gpm)

MD12M performance curve at max. and min. setting

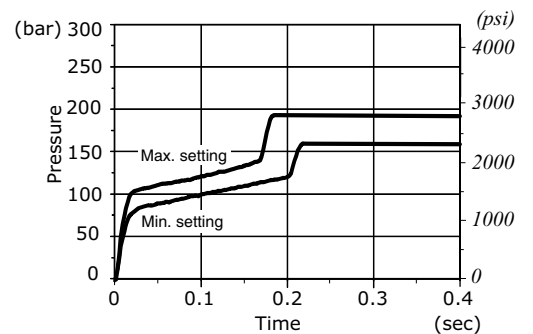

MD12M pressure vs. flow at max. and min. setting

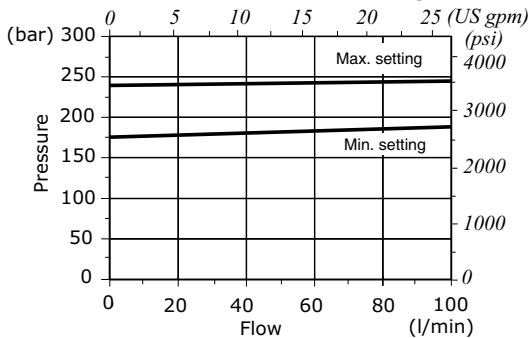

Pressure range 13
180 ÷ 220 bar
(2610 ÷ 3190 psi)
Setting 220 bar (3190 psi) at 60 l/min
(16 US gpm)
Pressure ratio 2.2
Q=100 l/min
(26.4 US gpm)

MD12M performance curve at max. and min. setting

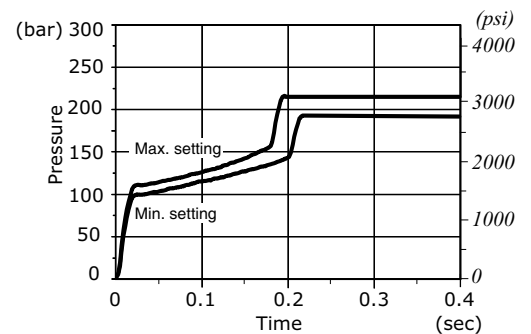

Rating diagrams

MD12M pressure vs. flow
at max. and min. setting

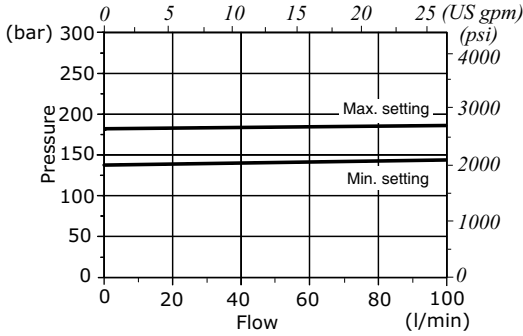

Pressure range 21
150÷185 bar
(1900÷2685 psi)
Pressure ratio 2
Q=100 l/min
(26.4 US gpm)

MD12M performance curve
at max. and min. setting

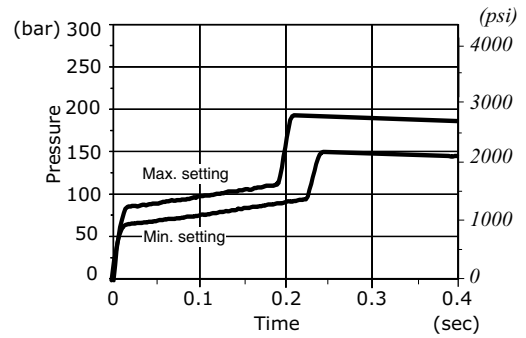

MD12M pressure vs. flow
at max. and min. setting

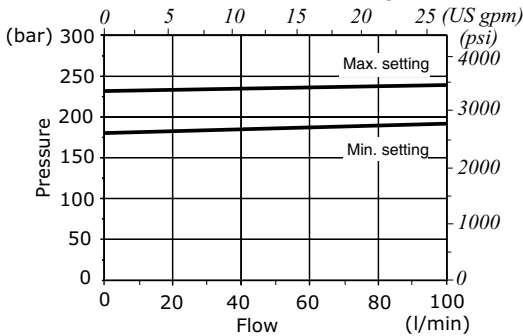

Pressure range 22
190÷235 bar
(2760÷3400 psi)
Pressure ratio 2.35
Q=100 l/min
(26.4 US gpm)

MD12M performance curve
at max. and min. setting

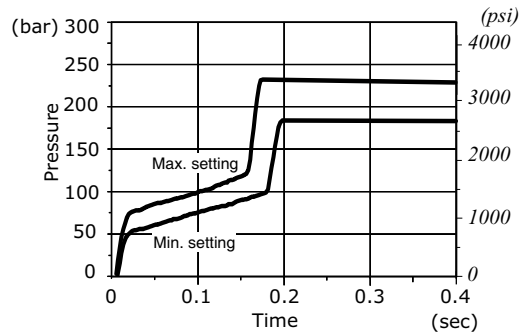

MD12M pressure vs. flow
at max. and min. setting

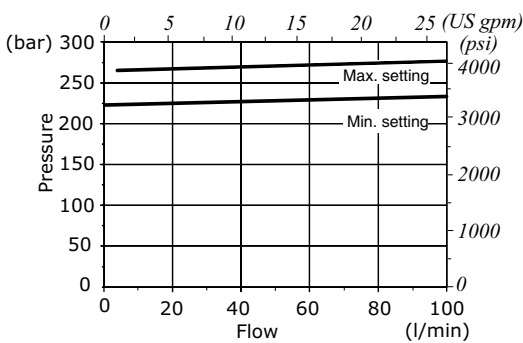

Pressure range 23
230÷275 bar
(3335÷3990 psi)
Pressure ratio 2.55
Q=100 l/min
(26.4 US gpm)

MD12M performance curve
at max. and min. setting

