



PP..A type flow control pressure compensated valves - 3 way

- With exceeding flow to pressure
- From SAE08 to SAE16 cavities

Technical specifications and diagrams are measured with mineral oil of 46 cSt viscosity at 40°C (104°F) temperature.

	PP08A	PP10A	PP12A	PP16A
Nominal flow	Q1max= 20 l/min (5.2 US gpm)	50 l/min (13.2 US gpm)	90 l/min (23.8 US gpm)	150 l/min (39.6 US gpm)
	Q3max= 15 l/min (4 US gpm)	30 l/min (7.9 US gpm)	50 l/min (13 US gpm)	90 l/min (24 US gpm)
Max. pressure	350 bar (5100 psi)			
Fluid	mineral based oil			
Viscosity	10-200 cSt			
Max level of contamination	20/18/14 ISO4406			
Fluid temperature	with NBR seals		from -20°C (-4°F) to 80°C (176°F)	
	with FPM seals		from -20°C (-4°F) to 100°C (212°F)	
Environmental temp. for working conditions	from -20°C (-4°F) to 50°C (122°F)			
Cavity	SAE 08/3	SAE 10/3	SAE 12/3	SAE 16/3
Weight	0.15 kg (0.33 lb)	0.20 kg (0.44 lb)	0.42 kg (0.92 lb)	0.57 kg (1.26 lb)

NOTE - For different conditions, please contact Walvoil Sales Dpt.

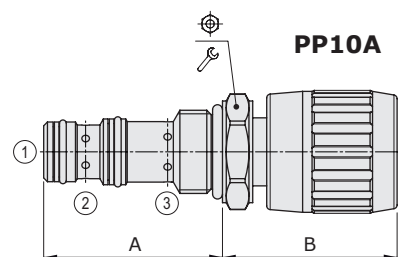
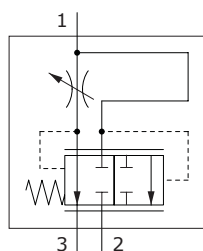

Valve type	A		B		⊕	🔧	Nm	lbft
	mm	in	mm	in				
PP08A/AM	41.1	1.62	49.5	1.95	24	30	22	
PP10A/AM	47.2	1.86	44	1.73	27	50	37	
PP12A/AM	73.5	2.89	45	1.77	32	80	59	
PP16A/AM	75	2.95	52	1.93	41	100	74	

For dimensions with different type of adjustment see page 212

Ordering codes and description composition

PP08A/AM0B

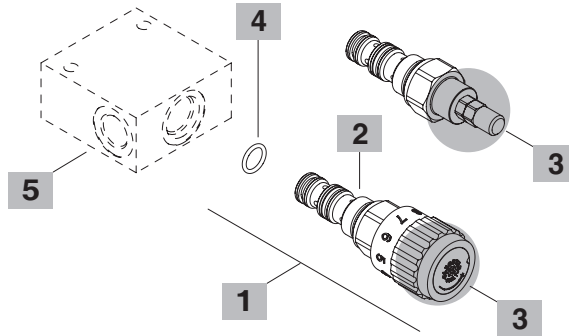
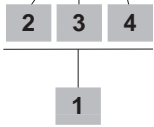

1 Cartridges

TYPE	CODE	DESCRIPTION
SAE cavity 08/3		
PP08A/AM0B	OPP08002000	Handknob adjustment
PP08A/AS0B	OPP08002004	Screw type adjustment
SAE cavity 10/3		
PP10A/AM0B	OPP10002000	Handknob adjustment
PP10A/AS0B	OPP10002005	Screw type adjustment
SAE cavity 12/3		
PP12A/AM0B	OPP12002000	Handknob adjustment
PP12A/AS0B	OPP12002004	Screw type adjustment
SAE cavity 16/3		
PP16A/AM0B	OPP16002001	Handknob adjustment
PP16A/AS0B	OPP16002006	Screw type adjustment

2 Pressure drop from 1 to 2

TYPE	DESCRIPTION
A	12 bar (170 psi)

3 Adjustments

TYPE	DESCRIPTION
S	Screw
M	Handknob

4 Seals

TYPE	DESCRIPTION
B	NBR (Buna) Std configuration without addition
V	For valve with FPM (Viton) o-ring seals, contact Sales Dept.

5 Valve body

TYPE	CODE	DESCRIPTION
SAE 08/3-G 3/8	3CC0830C11	Aluminium body for cavity 08 valve, G3/8 std thread
SAE 10/3-G 3/8	3CC1030C11	Aluminium body for cavity 10 valve, G3/8 std thread
SAE 12/3-G 1/2	3CC1230D11	Aluminium body for cavity 12 valve, G1/2 std thread
SAE 16/3-G 3/4	3CC1630E11	Aluminium body for cavity 16 valve, G3/4 std thread

Note: aluminium body can stand up to 210 bar (3050 psi)
For steel bodies or different threading see from page 217

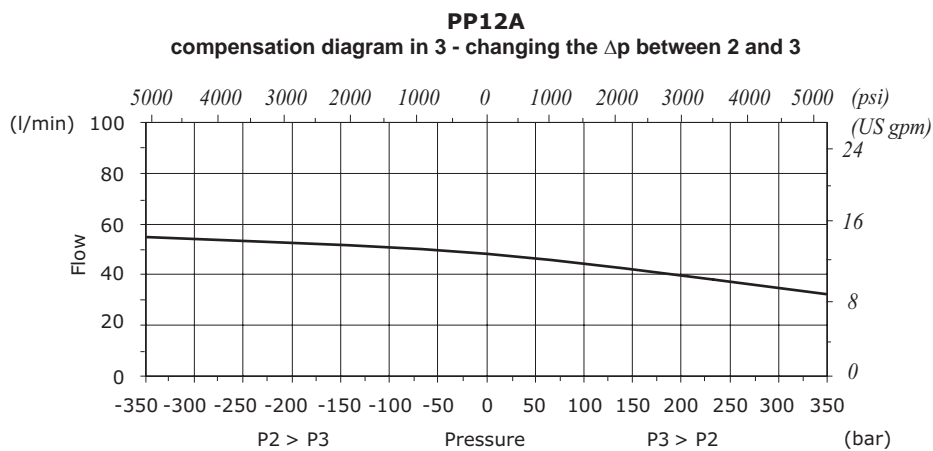
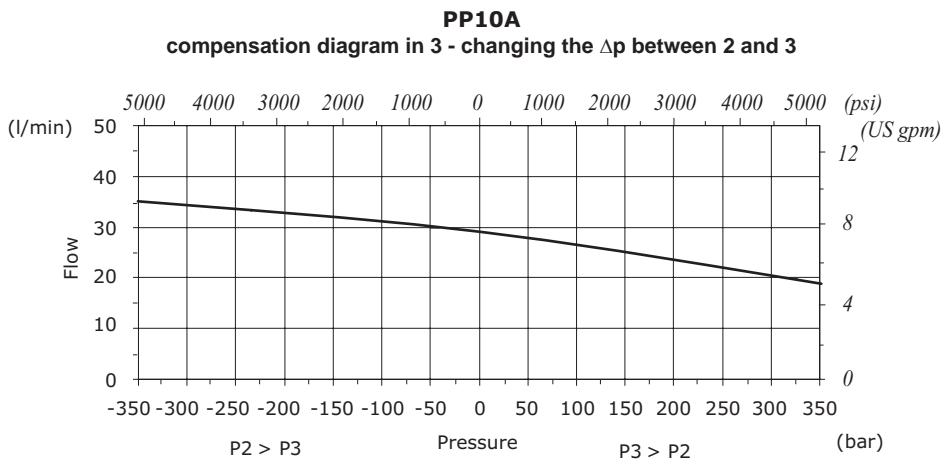
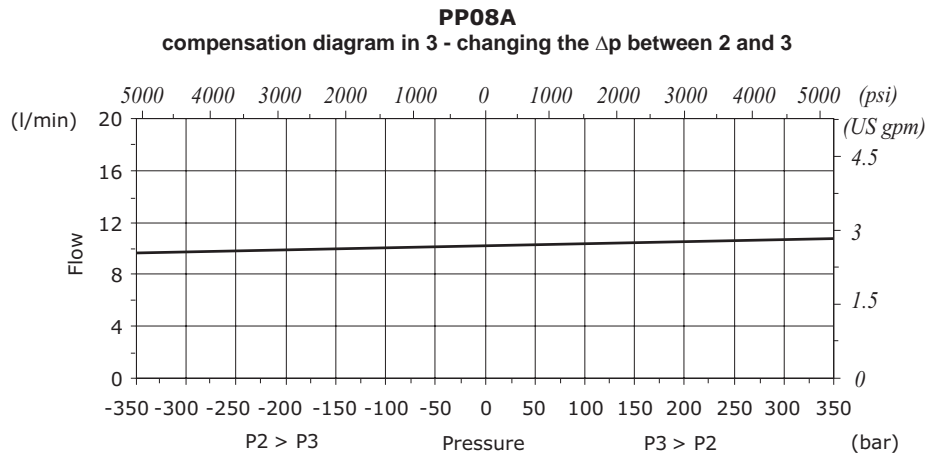

Rating diagrams

