**Technical Features**

- › Decreasing pressure output proportional with increasing DC current input
- › Low hysteresis, accurate pressure control
- › Wide pressure range up to 350 bar
- › Mechanical adjustment of minimum cracking pressure
- › Solenoid electrical terminal option acc. to EN 175301-803-A, AMP Junior Timer or Deutsch DT04-2P
- › 12 or 24 V DC coils
- › Usable as pilot stage of SRN4P1-B2 and SPN4P1-B3 proportional valves
- › In the standard version, the valve is zinc-coated for 240 h protection acc. to ISO 9227

**Functional Description**

A direct operated proportional poppet pressure relief valve in the form of a screw-in cartridge. The valve is designed for continuous regulation of system pressure. It is used mostly as a pilot stage. To set the minimum cracking pressure use the adjusting screw (s=5) which incorporates also the air bleed screw. Back pressure on port T becomes additive to the pressure setting of the valve. Air bleeding is necessary for the correct function of the valve. Installation: When possible, the valve should be mounted below the reservoir oil level. This will keep oil in the actuator at all times, preventing instability caused by air enclosures. If this is not possible, mount the valve for best results vertically downward with proper air bleeding.

**Technical Data**

Valve size / Cartridge cavity		3/4-16 UNF-2A / A2	
Max. operating pressure (port P)	bar (PSI)	350 (5080)	
Max. operating pressure (port T)	bar (PSI)	100 (1450)	
Max. flow	l/min (GPM)	1.5 (0.40)	
Fluid temperature range (NBR)	°C (°F)	-30 ... +120 (-22 ... 248)	
Fluid temperature range (FPM)	°C (°F)	-20 ... +120 (-4 ... 248)	
Ambient temperature range	°C (°F)	-30 ... +80 (-22 ... 176)	
Hysteresis	%	< 5	
<b>Solenoid data</b>			
Supply voltage	V	12 DC	24 DC
Max. current	A	1	0,6
Rated resistance at 20 °C (68 °F)	Ω	6.5 ± 5 %	20.6 ± 5 %
Duty cycle	%	100	
Optimal PWM frequency	Hz	160 - 200	
Quenching diode		BZW06-19B	BZW06-33B
Enclosure type acc.to EN 60529**		IP65 / IP67 / IP69K	
Weight with solenoid	kg (lbs)	0.44 (0.97)	
	Data Sheet	Type	
General information	GI_0060	Products and operating conditions	
Coil types	C_8007	C19B*	
Valve bodies	In-line mounted	SB_0018	SB-A2*
	Sandwich mounted	SB-04(06)_0028	SB-*A2*
Cavity details / Form tools	SMT_0019	SMT-A2*	
Spare Parts	SP_8010		

\*\*The indicated IP protection level is reached only with a properly mounted connector.

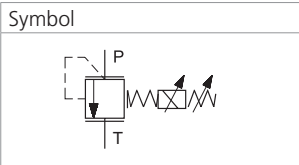

**Dimensions** in millimeters (inches)

**Connector type**

 E1, E2 - IP65  
 EN 175301-803-A

 E3, E4 - IP67  
 AMP Junior Timer  
 - radial

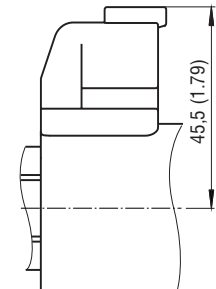
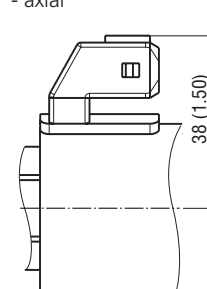
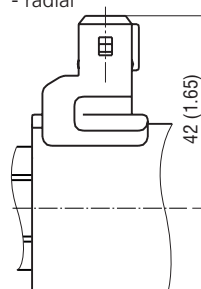
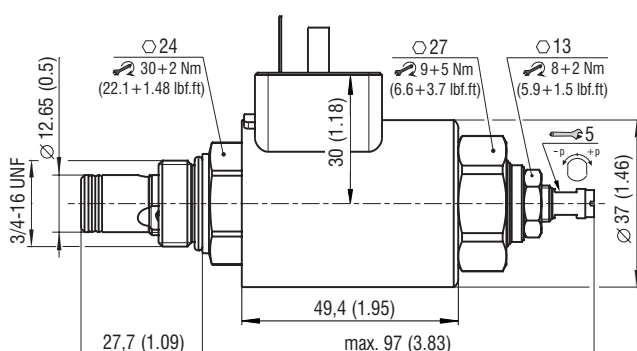
 E3A, E4A - IP67  
 AMP Junior Timer  
 - axial

 E12A, E13A - IP67 / IP69K  
 Deutsch DT04-2P

**Characteristics** measured at  $v = 32 \text{ mm}^2/\text{s}$  (156 SUS)

**Relief pressure related to control signal**

$Q=0.2 \text{ l/min}$  (0.05 GPM), pressure in port T=0 bar, PWM 160Hz

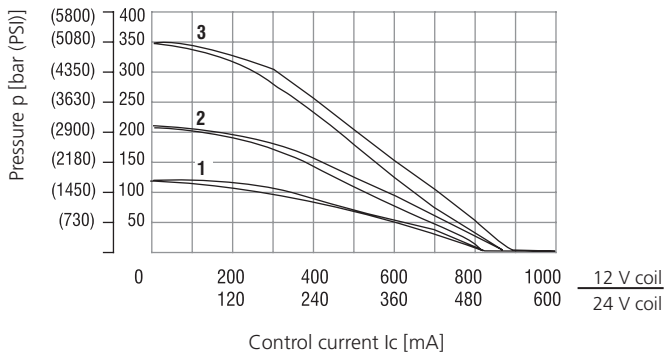

Pressure range	12	21	35
	1	2	3

**Relief pressure related to flow rate**

Pressure range 35, various control currents

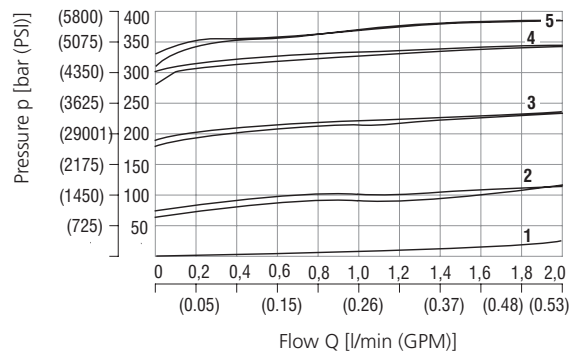

Control current	1	2	3	4	5
	100 % $I_{max}$	75 % $I_{max}$	50 % $I_{max}$	25 % $I_{max}$	0 % $I_{max}$

**Pressure drop related to flow rate**

100% of control current, P-T direction

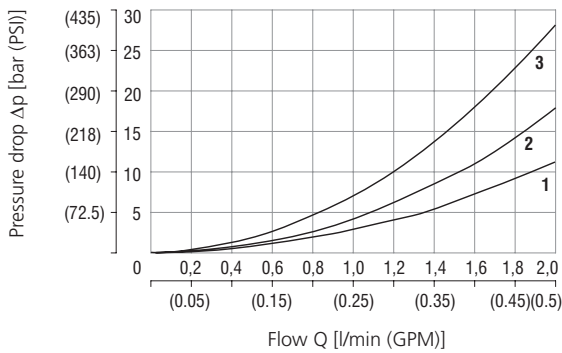

Pressure range	12	21	35
	1	2	3

**Ordering Code**

SRN1P1 - A2 / H - - - -

**Proportional pressure control valve, relieving, direct-acting, inverted**

**Valve cavity**  
3/4-16UNF

**Model**  
High performance

**Max. regulated pressure**  
up to 120 bar (1740 PSI) **12**  
up to 210 bar (3046 PSI) **21**  
up to 350 bar (5076 PSI) **35**

**Supply voltage / max. current**  
12 V DC / 1 A **12**  
24 V DC / 0.6 A **24**

**Surface treatment**  
**A** zinc-coated (ZnCr-3), ISO 9227 (240 h)  
**B** zinc-coated (ZnNi), ISO 9227 (520 h)

**No designation**  
**V**

**Seals**  
NBR  
FPM (Viton)

**Connector type**  
EN 175301-803-A  
**E1** E1 with quenching diode  
**E2** E2 with quenching diode  
**E3** AMP Junior Timer - radial direction (2 pins; male)  
**E4** E3 with quenching diode  
**E3A** AMP Junior Timer - axial direction (2 pins; male)  
**E4A** E3A with quenching diode  
**E12A** Deutsch DT04-2P - axial direction  
**E13A** E12A with quenching diode

For other solenoid terminals see data sheet No. 8007