

VPN1-20/S

M30 x 1,5 • Q_{max} 250 l/min (66 GPM) • p_{max} 420 bar (6100 PSI)

Model S

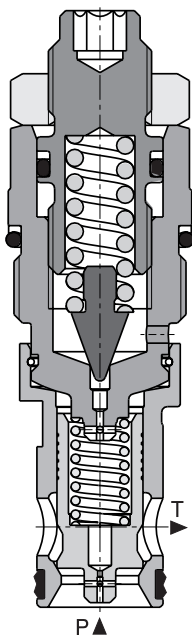

Technical Features

- › Excellent stability throughout flow range with rapid response to dynamic pressure changes
- › Low hysteresis, accurate pressure control and low pressure drop
- › Wide pressure range up to 420 bar
- › High flow capacity
- › Hardened precision parts
- › Ideal for use as control valve where accuracy and repeatability is required
- › External pilot and drain option
- › Adjustable by allen key or hand screw, optionally sealable (lockwire holes)
- › In the standard version, the valve is zinc-coated for 240 h protection acc. to ISO 9227

Functional Description

A pilot-operated, spool-type hydraulic relief valve in the form of a screw-in cartridge intended for use as a pressure limiting device. Fast-acting with low hysteresis. Because of the absence of any internal seals, the valve shows excellent reseating and repeatability characteristics. It may be used as a main pressure control element but due to its two stage design it is not recommended for safety applications where operating speed is critical. Version SX has an external pilot line, version SY allows a separate drain connection.

Model	S	SX	SY
Symbol			

Technical Data

Valve size		M30 x 1,5/RB2	M30 x 1,5/RB3
Model		S, SY	SX
Max. flow	l/min (GPM)	250 (66)	
Max. pressure ports (P, X)	bar (PSI)	420 (6100)	
Max. pressure ports (T, Y)	bar (PSI)	160 (2320)	
Fluid temperature range (NBR)	°C (°F)	-30 ... +100 (-22 ... 212)	
Fluid temperature range (FPM)	°C (°F)	-20 ... +120 (-4 ... 248)	
Weight	kg (lbs)	0.3 (0.66)	

	Datasheet	Type	
General information	GI_0060	Products operating conditions	
Valve bodies	In-line mounted	SB-RB2*	SB-RB3*
Cavity details	SMT_0019	SMT-RB2*	SMT-RB3*
Spare parts	SP_8010		

Characteristics measured at $v = 32 \text{ mm}^2/\text{s}$ (156 SUS)

Relief pressure related to flow rate

Model S

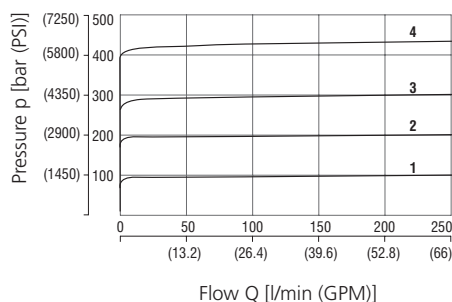

Relief pressure related to flow rate

Model SY

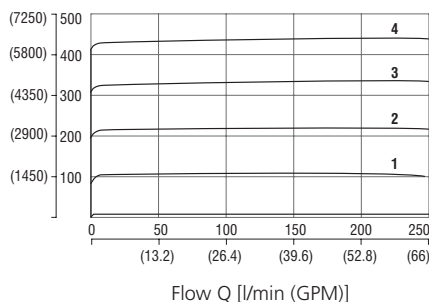

Minimum set and circulation pressure

Model S, SX, SY

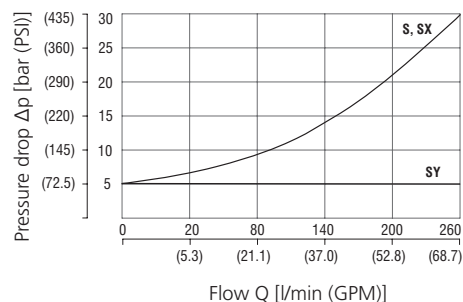

Dimensions in millimeters (inches)

VPN1-20/S

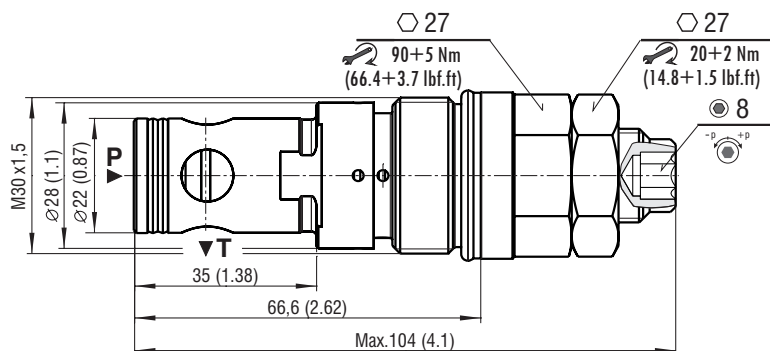

VPN1-20/SX

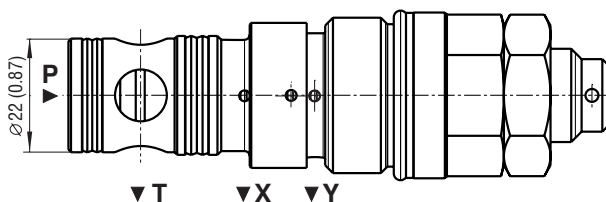

VPN1-20/SY

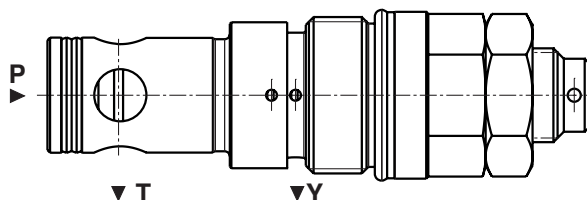

Ordering Code

VPN1-20 /						
Pressure relief valve, spool-type, pilot-operated, external pilot and drain M30 x 1,5						
	Model internal pilot and drain external pilot, external drain internal pilot, external drain	S	SX	SY		
Pressure range 10 ... 420 bar (145 ... 6100 PSI)		42			S	
						Surface treatment A zinc-coated (ZnCr-3), ISO 9227 (240 h) B zinc-coated (ZnNi), ISO 9227 (520 h)
						Seals No designation V
						Adjustment option allen key (hex. 6), without protective cap