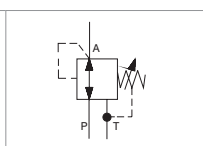

**Technical Features**

- › Excellent stability throughout flow range with rapid response to dynamic pressure changes
- › Low hysteresis, accurate pressure control and low pressure drop
- › Reverse relief protection
- › Wide pressure range up to 320 bar
- › High flow capacity
- › Hardened precision parts
- › Adjustable by allen key or hand screw, optionally sealable (lockwire holes)
- › In the standard version, the valve is zinc-coated for 240 h protection acc. to ISO 9227

**Functional Description**

This 3 way pilot operated pressure reducing valve is designed to reduce the system pressure at the consumer port. Due to its 3 way design the valve provides reverse relief protection of the secondary circuit to the tank port. The pressure can be set by an adjustment screw (by allen key or by hand screw) and the valve is optionally equipped with lockwire holes for sealing.

Symbol



**Technical Data**

Valve size / Cartridge cavity		M22 x 1.5 / QF3
Max. flow	l/min (GPM)	40 (10.6)
Max. control flow	l/min (GPM)	0.25 (0.07)
Max. operating pressure	bar (PSI)	320 (4640)
Max. pressure (T port)	bar (PSI)	160 (2320)
Fluid temperature range (NBR)	°C (°F)	-30 ... +100 (-22 ... 212)
Fluid temperature range (FPM)	°C (°F)	-20 ... +120 (-4 ... 248)
Weight	kg (lbs)	0.22 (0.49)
Datasheet		Type
General information		GL_0060
		Products and operating conditions
Valve bodies	In-line mounted	SB_0018
	Sandwich mounted	SB-04(06)_0028
Cavity details		SMT_0029
Spare parts		SP_8010
		SB-QF3*
		SB-04(06)-QF3*
		SMT-QF3*

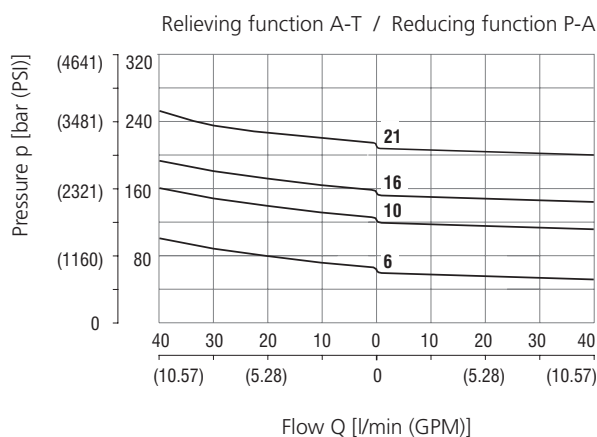

The volume flow, which is needed for control of output pressure and maintaining the adjusted value of reducing pressure, flows permanently through the pilot stage of valve.

**Characteristics** measured at  $v = 32 \text{ mm}^2/\text{s}$  (156 SUS)

**Reducing - relieving pressure related to flow rate**

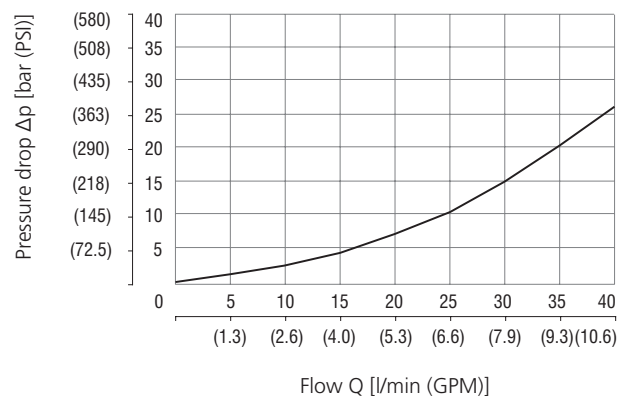
**Pressure drop related to flow rate**

 Flow direction P-A  
 Fully open valve cross section

**Dimensions** in millimeters (inches)

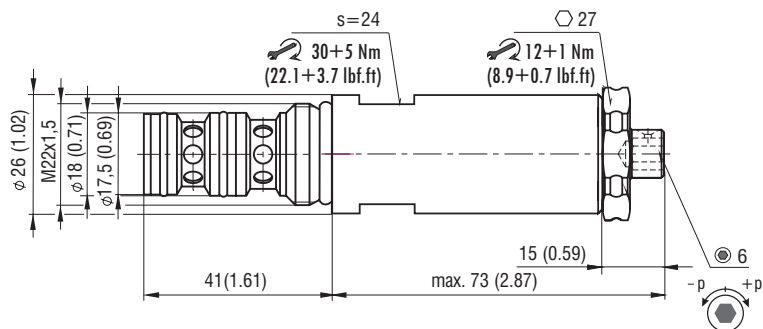
**Model S**



**Model T**

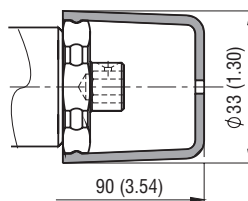

**Model RS**

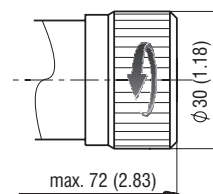

**Model RP**

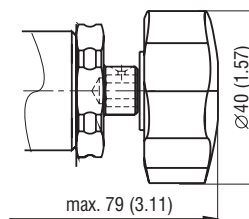

**Model L**

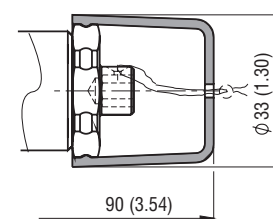

**Ordering Code**

VRN2-06 / S -    -

**Pressure reducing - relieving valve, spool type, pilot operated** M22 x 1.5

**Model**  
screw-in cartridge

**Pressure range**  
up to 63 bar (910 PSI)  
up to 100 bar (1450 PSI)  
up to 160 bar (2320 PSI)  
up to 210 bar (3045 PSI)

**6**  
**10**  
**16**  
**21**

**Surface treatment**  
**A** zinc-coated (ZnCr-3), ISO 9227 (240 h)  
**B** zinc-coated (ZnNi), ISO 9227 (520 h)

**No designation**  
**V**

**Seals**  
NBR  
FPM (Viton)

**Adjustment option**  
allen key (hex. 6), without protective cap  
allen key (hex. 6), with protective cap  
hand screw, metal  
hand screw, plastic  
allen key (hex. 6), with protective cap, sealable (lockwire holes)

**S**  
**T**  
**RS**  
**RP**  
**L**