

Pressure Reducing - Relieving Valve, Spool Type, Pilot Operated

VRN2-10/S

M27 x 2 • Q_{max} 150 l/min (40 GPM) • p_{max} 320 bar (4600 PSI)

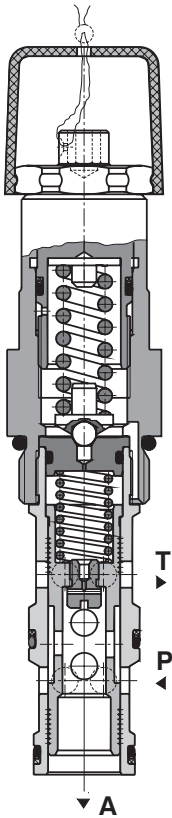

Technical Features

- › Excellent stability throughout flow range with rapid response to dynamic pressure changes
- › Low hysteresis, accurate pressure control and low pressure drop
- › Reverse relief protection
- › Wide pressure range up to 320 bar
- › High flow capacity
- › Hardened precision parts
- › Adjustable by allen key or hand screw, optionally sealable (lockwire holes)
- › In the standard version, the valve is zinc-coated for 240 h protection acc. to ISO 9227

Functional Description

This 3 way pilot operated pressure reducing valve is designed to reduce the system pressure at consumer port. Due to its 3 way design the valve provides reverse relief protection of the secondary circuit to the tank port. The pressure can be set by an adjustment screw (by allen wrench or by hand) and the valve is optionally equipped with lockwire holes for sealing.

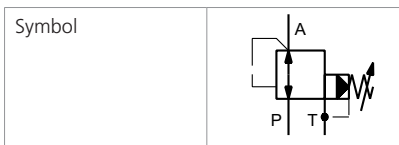

Technical Data

Valve size / Cartridge cavity		M27 x 2 / K3
Max. flow	l/min (GPM)	150 (39.6)
Max. control flow	l/min (GPM)	0.65 (0.17)
Max. operating pressure	bar (PSI)	320 (4640)
Max. pressure (port T)	bar (PSI)	160 (2320)
Fluid temperature range (NBR)	°C (°F)	-30 ... +100 (-22 ... 212)
Fluid temperature range (FPM)	°C (°F)	-20 ... +120 (-4 ... 248)
Weight	kg (lbs)	0.35 (0.77)
Datasheet		Type
General information		GI_0060
Products and operating conditions		
Valve bodies	In-line mounted	SB_0018
	Sandwich mounted	SB-04(06)_0028
Cavity details		SMT_0029
Spare parts		SP_8010
		SB-K3*
		SB-04(06)-K3*
		SMT-K3*



The volume flow, which is needed for control of output pressure and maintaining the adjusted value of reducing pressure, flows permanently through the pilot stage of valve.

Characteristics measured at $v = 32 \text{ mm}^2/\text{s}$ (156 SUS)

Reducing - relieving pressure related to flow rate

Relieving function A-T / Reducing function P-A

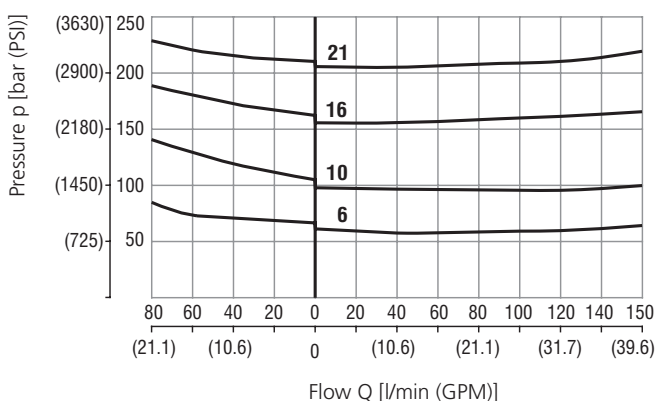

Pressure drop related to flow rate

Flow direction P-A
Fully open valve cross section

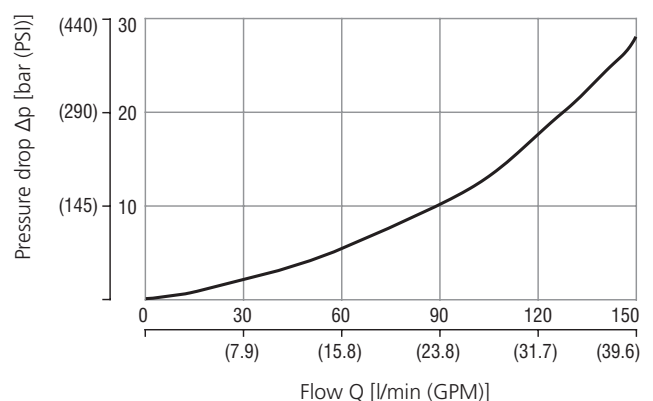

Dimensions in millimeters (inches)

Model S

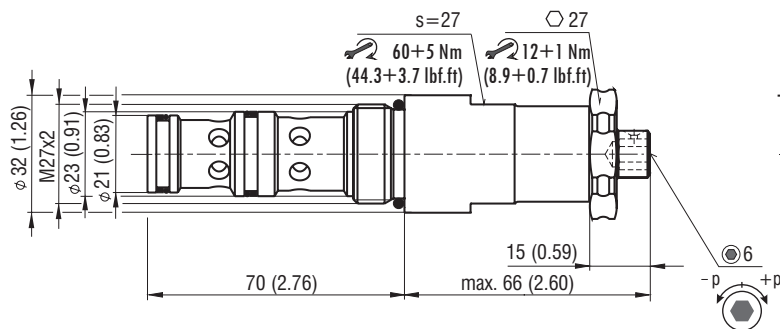

Model T

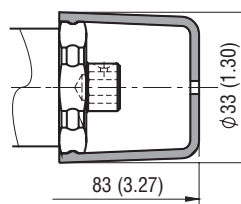

Model RS

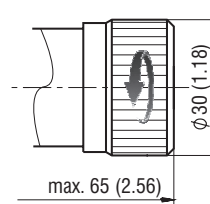

Model RP

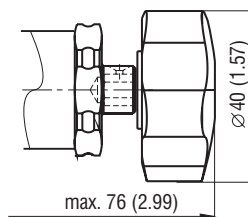

Model L

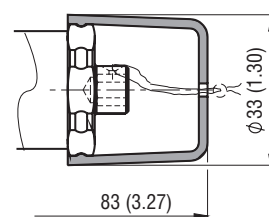

Ordering Code

VRN2-10 / S - -

Pressure reducing - relieving valve,
spool type, pilot operated M27 x 2

Model
screw-in cartridge

Pressure range

up to 63 bar (910 PSI)	6
up to 100 bar (1450 PSI)	10
up to 160 bar (2320 PSI)	16
up to 210 bar (3045 PSI)	21

Surface treatment

A	zinc-coated (ZnCr-3), ISO 9227 (240 h)
B	zinc-coated (ZnNi), ISO 9227 (520 h)

No designation
V

Seals
NBR
FPM (Viton)

Adjustment option

S	allen key (hex. 6), without protective cap
T	allen key (hex. 6), with protective cap
RS	hand screw, metal
RP	hand screw, plastic
L	allen key (hex. 6), with protective cap, sealable (lockwire holes)