

GMV15

DISTRIBUTORI MONOBLOCCO MONOBLOCK DIRECTIONAL CONTROL VALVES

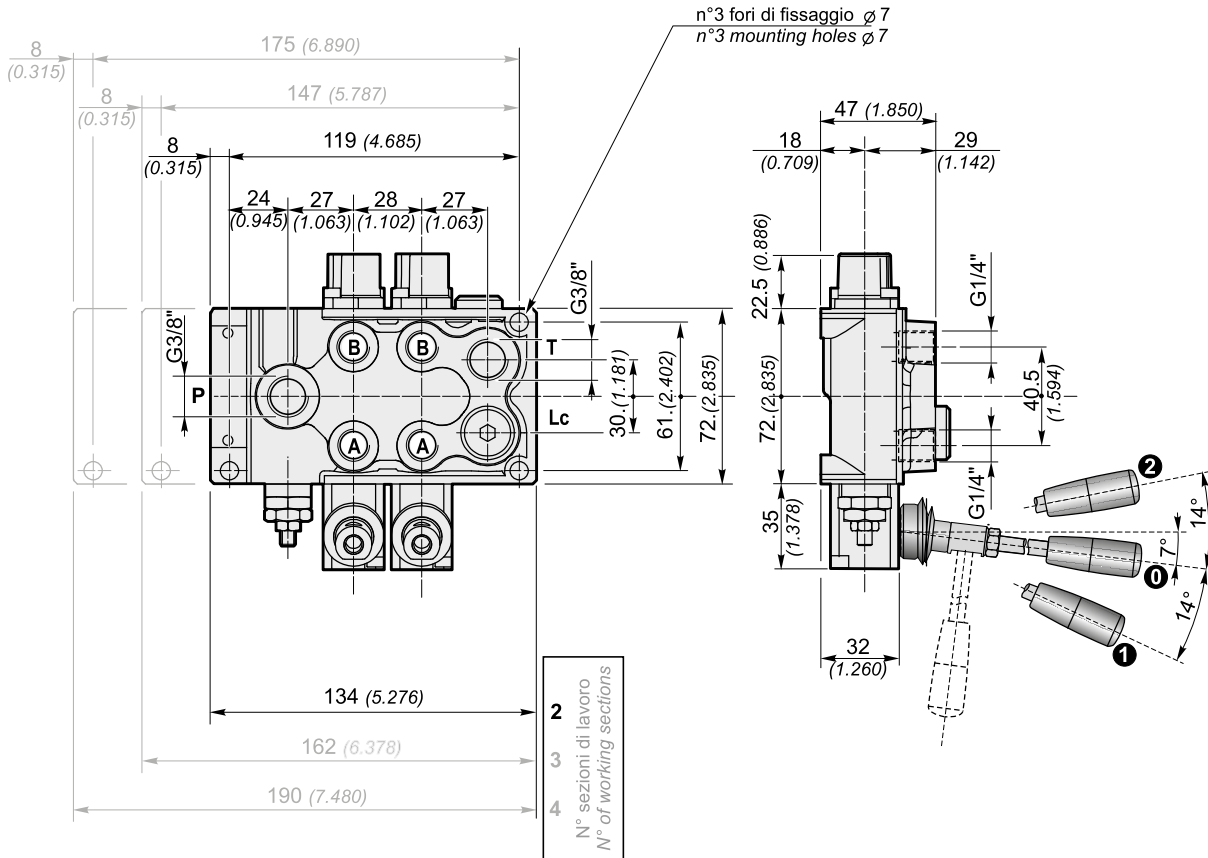
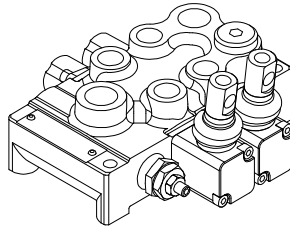

Filettature disponibili / Available ports

Bocche Ports	BSP (standard)	SAE
P	G 3/8"	3/4" - 16UNF (SAE 8)
A - B	G 1/4"	9/16" - 18UNF (SAE 6)
T	G 3/8"	3/4" - 16UNF (SAE 8)
Lc	G 3/8"	3/4" - 16UNF (SAE 8)

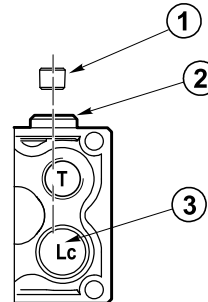

Come fare la funzione carry-over

Togliere il tappo ② montare il tappo conico G1/8" ① e rimontare il tappo ②. Togliere il tappo della libera circolazione ③.

Come fare la funzione centro chiuso

Togliere il tappo ② montare il tappo conico G1/8" ① e rimontare il tappo ②. Montare il tappo della libera circolazione ③.

How to make the carry-over function

Remove the plug ② mount a conical plug G1/8" ① and reassemble the plug ②. Remove the plug on the carry-over port ③.

How to make the closed center function

Remove the plug ② mount a conical plug G1/8" ① and reassemble the plug ②. Mounting the plug on the carry-over port ③.

GMV15

DISTRIBUTORI MONOBLOCCO MONOBLOCK DIRECTIONAL CONTROL VALVES

Perdite di carico con il cursore in posizione neutra
Pressure drop with spool in neutral position

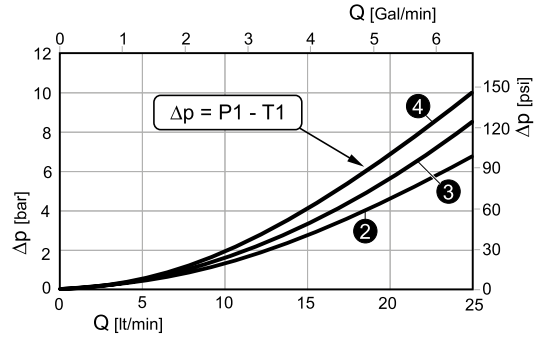
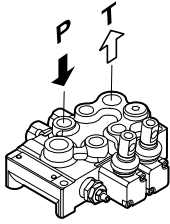

Perdite di carico con il cursore in posizione di lavoro
Pressure drop with spool in working position

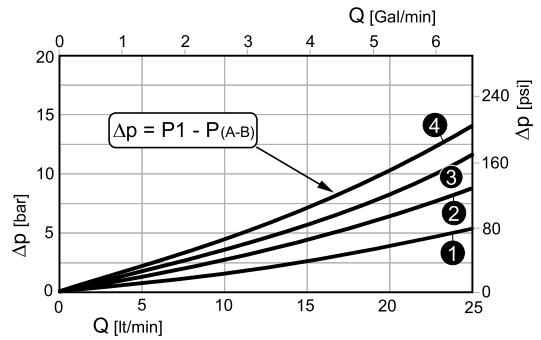
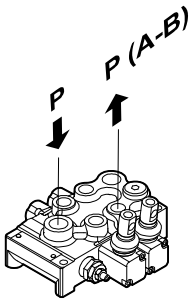

Perdite di carico con il cursore in posizione di lavoro
Pressure drop with spool in working position

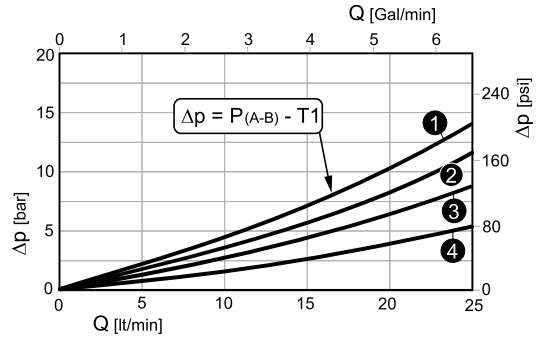
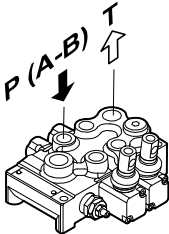

1 2 3 4 Sezioni / Sections

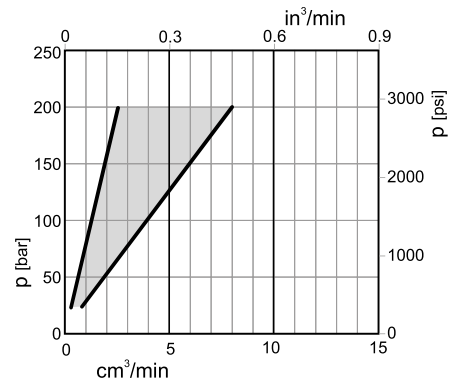
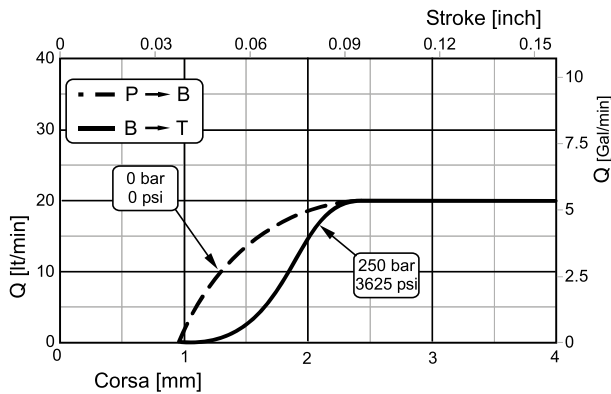

N.B. Le curve sono state effettuate con olio Tellus 46 a 40 °C e cursore 103.
NOTE. The tests were performed with Tellus 46 oil to 40 °C and spool 103 type.